



GV470 / GV471

Impulse splitters for incremental encoders - with 4 or 8 output channels

Product features:

- Power supply from 10 up to 30 VDC
- 1 encoder input for channels A, /A, B, /B, Z, /Z
- Input levels selectable between RS422, TTL and HTL
- Types with 4 or 8 outputs available (see below)
- Selectable output levels (RS422 / TTL / HTL)
- Auxiliary 5.5 VDC encoder supply output
- Easy cascading of further devices possible (incl. select function)

Available devices:

GV 470: Pulse splitter with 8 output channels

GV 471: Pulse splitter with 4 output channels

Version:	Description:
GV47001a/Feb06/HK	First edition
GV47001b/Feb06/HK	Improved block diagram
GV47001c/April09/HK	Extensions for GV471
Gv470_01d_oi/Sep-15/ag	"Safety Instructions", "Technical Specifications" and design updated

Legal notices:
All contents included in this manual are protected by the terms of use and copyrights of motrona GmbH. Any reproduction, modification, usage or publication in other electronic and printed media as well as in the internet requires prior written authorization by motrona GmbH.

Table of Contents

1.	Safety Instructions and Responsibility	4
1.1	General Safety Instructions	4
1.2	Use according to the intended purpose	4
1.3	Installation	5
1.4	Cleaning, Maintenance and Service Notes	5
2.	Introduction and Block Diagram	6
3.	Electrical Connections and LED Function	8
3.1.	Power Supply and LEDs	8
3.2.	Auxiliary Encoder Supply	8
3.3.	Impulse inputs	9
3.3.1.	TTL encoders with differential outputs (suitable for signal levels up to 5.5 volts according to RS422 standard)	9
3.3.2.	Encoders with single-ended outputs, without inverted signals (suitable for HTL levels >15 volts only)	9
3.3.3.	HTL encoders with differential outputs (suitable for signal levels from 10 to 30 volts)	9
3.3.4.	Differential signals for encoder channels A, /A, B, /B, but single-ended marker pulse from proximity switch or photocell	10
3.4.	Impulse outputs	10
3.5.	Cascading of Several Units and Encoder Select Function	11
4.	Technical Specifications	12
5.	Dimensions	13

1. Safety Instructions and Responsibility

1.1 General Safety Instructions

This operation manual is a significant component of the unit and includes important rules and hints about the installation, function and usage. Non-observance can result in damage and/or impairment of the functions to the unit or the machine or even in injury to persons using the equipment!

Please read the following instructions carefully before operating the device and observe all safety and warning instructions! Keep the manual for later use.

A pertinent qualification of the respective staff is a fundamental requirement in order to use these manual. The unit must be installed, connected and put into operation by a qualified electrician.

Liability exclusion: The manufacturer is not liable for personal injury and/or damage to property and for consequential damage, due to incorrect handling, installation and operation. Further claims, due to errors in the operation manual as well as misinterpretations are excluded from liability.

In addition the manufacturer reserve the right to modify the hardware, software or operation manual at any time and without prior notice. Therefore, there might be minor differences between the unit and the descriptions in operation manual.

The raiser respectively positioner is exclusively responsible for the safety of the system and equipment where the unit will be integrated.

During installation or maintenance all general and also all country- and application-specific safety rules and standards must be observed.

If the device is used in processes, where a failure or faulty operation could damage the system or injure persons, appropriate precautions to avoid such consequences must be taken.

1.2 Use according to the intended purpose

The unit is intended exclusively for use in industrial machines, constructions and systems. Non-conforming usage does not correspond to the provisions and lies within the sole responsibility of the user. The manufacturer is not liable for damages which has arisen through unsuitable and improper use.

Please note that device may only be installed in proper form and used in a technically perfect condition - in accordance to the Technical Specifications (see chapter 4). The device is not suitable for operation in explosion-proof areas or areas which are excluded by the EN 61010-1 standard.

1.3 Installation

The device is only allowed to be installed and operated within the permissible temperature range. Please ensure an adequate ventilation and avoid all direct contact between the device and hot or aggressive gases and liquids.

Before installation or maintenance, the unit must be disconnected from all voltage-sources. Further it must be ensured that no danger can arise by touching the disconnected voltage-sources.

Devices which are supplied by AC-voltages, must be connected exclusively by switches, respectively circuit-breakers with the low voltage network. The switch or circuit-breaker must be placed as near as possible to the device and further indicated as separator.

Incoming as well as outgoing wires and wires for extra low voltages (ELV) must be separated from dangerous electrical cables (SELV circuits) by using a double resp. increased isolation.

All selected wires and isolations must be conform to the provided voltage- and temperature-ranges. Further all country- and application-specific standards, which are relevant for structure, form and quality of the wires, must be ensured. Indications about the permissible wire cross-sections for wiring are described in the Technical Specifications (see chapter [4](#)).

Before first start-up it must be ensured that all connections and wires are firmly seated and secured in the screw terminals. All (inclusively unused) terminals must be fastened by turning the relevant screws clockwise up to the stop.

Overvoltages at the connections must be limited to values in accordance to the overvoltage category II.

For placement, wiring, environmental conditions as well as shielding and earthing/grounding of the supply lines the general standards of industrial automation industry and the specific shielding instructions of the manufacturer are valid. Please find all respective hints and rules on www.motrona.com/download.html --> "[General EMC Rules for Wiring, Screening and Earthing]".

1.4 Cleaning, Maintenance and Service Notes

To clean the front of the unit please use only a slightly damp (not wet!), soft cloth. For the rear no cleaning is necessary. For an unscheduled, individual cleaning of the rear the maintenance staff or assembler is self-responsible.

During normal operation no maintenance is necessary. In case of unexpected problems, failures or malfunctions the device must be shipped for back to the manufacturer for checking, adjustment and reparation (if necessary). Unauthorized opening and repairing can have negative effects or failures to the protection-measures of the unit.

2. Introduction and Block Diagram

GV470 and GV471 represent a series of incremental encoder splitters with a most compact, space-saving design and with most versatile technical features. Both models are fully identical except for the number of output channels (4 or 8 channels)

Both products provide potential separation between the input and the outputs, whilst the outputs among each other and the power supply use the same common GND potential.

**Where an overall potential separation between all circuits is required,
please refer to models GV480 and GV481**

The encoder input is switch-selectable for operation with either standard RS422 signals, with differential TTL or HTL signals or with single-ended HTL encoder signals. All encoder outputs provide push-pull drivers with individual assignment of the output level for each of the output channels.

Separate cascading ports provide easy cascading of multiple units without loss of regular encoder outputs. Furthermore, cascaded units allow selection and commutation between different encoder inputs.

The adjoining block diagram clearly explains the principle of operation and the potential conditions between all circuits. For simplification the illustration shows only two of the outputs, since all outputs are fully identical.

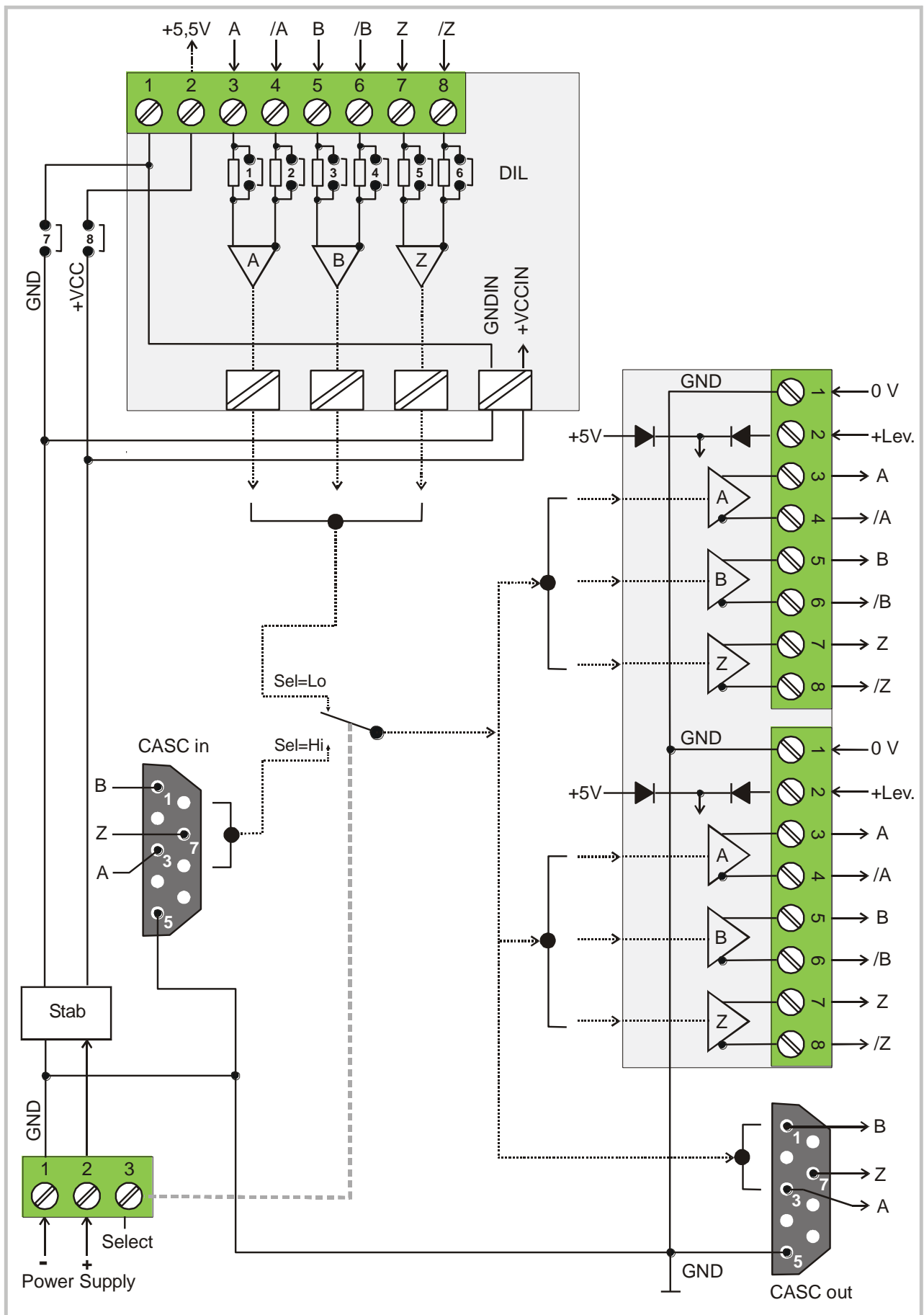

3. Electrical Connections and LED Function

3.1. Power Supply and LEDs

The unit provides a 3-position screw terminal strip for supply from a 10 – 30 volts DC power unit. The current consumption is approx. 100 mA (no-load operation).

The “Select” input terminal provides selection of the desired source encoder. Details will be described later.

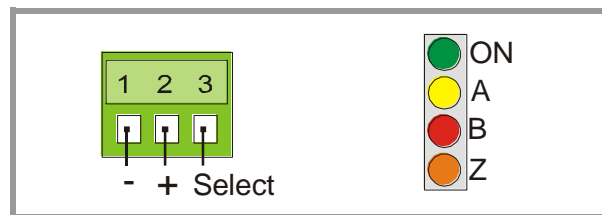

The upper LED (green) signals that power is applied to the unit.

The lower LEDs (yellow, red, orange) signal the actual logical states of the input channels A, B and Z. With very low input frequencies it is possible to visually check the input pulses, the phase displacement A/B and the index pulse function of an encoder.

3.2. Auxiliary Encoder Supply

The input encoder must be connected to the 8-position input terminal strip.

Depending on the application and the encoder type, one of the following options will apply for the power supply of the encoder:

- a) Remote supply via separate source
- b) Same power source that also supplies the GV470 unit (10 - 30 VDC) *)
- c) Use of the built-in auxiliary 5.5 volts power supply (terminal 2 of the input connector) *)



When the built-in 5,5 volts power should be used to supply the encoder, positions 7 and 8 of the DIL switch have to be set to "ON".

*) Suspends the galvanic separation of the input against outputs and power supply

3.3. Impulse inputs

The 8-position DIL switch on the front side provides setting of the desired signal formats and levels. These settings are separately for each of the channels A / B / Z (see block diagram). For simplification, a short form of the four most common applications is shown below, with the encoder supply omitted:

3.3.1. TTL encoders with differential outputs (suitable for signal levels up to 5.5 volts according to RS422 standard)

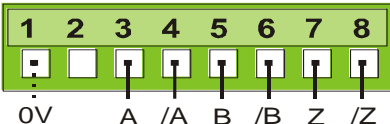
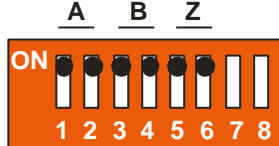
Terminal Connections	DIL Switch Setting
 <p>The common 0V terminal may be optionally connected or remain unconnected</p>	

3.3.2. Encoders with single-ended outputs, without inverted signals (suitable for HTL levels >15 volts only)

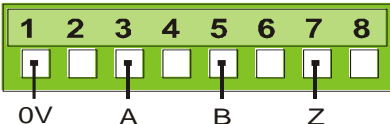
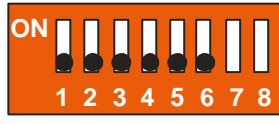
Terminal Connections	DIL Switch Setting
 <p>It is mandatory to connect the common 0V terminal</p>	

3.3.3. HTL encoders with differential outputs (suitable for signal levels from 10 to 30 volts)

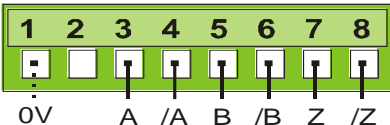
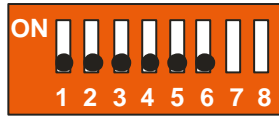
Terminal Connections	DIL Switch Setting
 <p>The common 0V terminal may be optionally connected or remain unconnected</p>	

3.3.4. Differential signals for encoder channels A, /A, B, /B but single-ended marker pulse from proximity switch or photocell

Besides the most common standard configurations shown before, the unit allows setting of any other input configuration. The block diagram shows which of the DIL switch positions is responsible for each of the channels. It is easy to figure out other settings from the examples given in this manual.

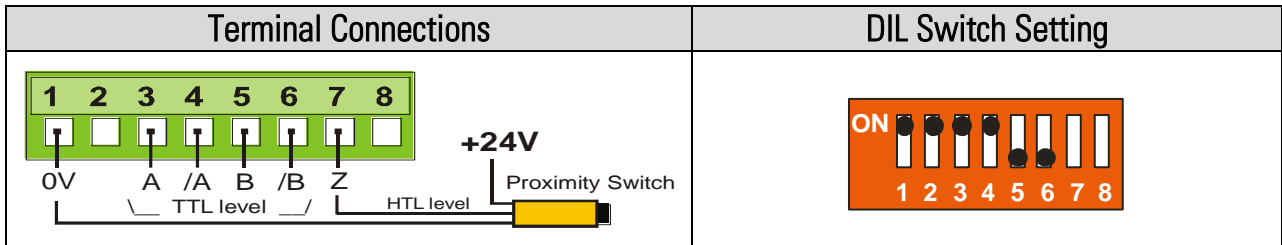

- The normal encoder input terminal will not accept any single-ended signals with TTL level, i.e. single-ended signals have to provide HTL level
- Nevertheless, in special cases, the cascading inputs of the unit can be used to apply single-ended TTL signals (CMOS input, Low <0.8 V, High >3.5 V). This however assumes proper EMC conditions and environment as well as short cables on the input side.
- The input terminal strip provides a codification to avoid accidental mix-up with the other connectors of the unit

3.4. Impulse outputs

All outputs always provide the non-inverted and the inverted signals, even when on the input side the inverted signals are not available.

If terminal "Level" of an output is unconnected, the corresponding output level will automatically be TTL (approx. 5 volts).

Applying any external voltage >5.5 volts between terminal 1 (0V) and terminal 2 (+Lev.) will increase the output level correspondingly (permitted range 5.5 ... 30 volts).

Each of the outputs can be connected to an individual external voltage, thus providing individual output swing on each of the output channels.

Output lines are short-circuit-proof and the maximum output current is 30 mA per line.

The terminal assignment can be found in the block diagram and is also printed to the front plate of the unit. All output terminal strips have the same codification, since it is fully unimportant to which of the outputs a terminal strip is connected (only the external voltage applied to the "Lev." input of the mating connector is responsible for the output level).

3.5. Cascading of Several Units and Encoder Select Function

The unit can be cascaded very easily to any number of output channels, without loss of regular encoder outputs. For cascading, pins 1, 3, 5 and 7 of the cascading output of the first unit must be connected to the corresponding pins of the cascading input of the follower unit.

An appropriate ribbon cable connection is available under motrona part # FK470

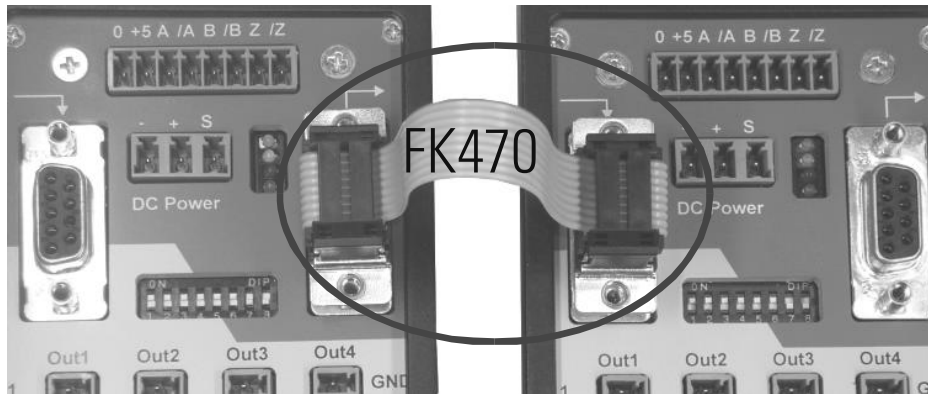

Cascaded units allow selection of the active source encoder via the encoder select input on the 3-position power connector (see also block diagram):

LOW (or open): outputs refer to the encoder input of the same unit

HIGH (10 – 30 volts): outputs refer to the encoder input of the preceding unit

It is possible at any time to switch over from one to the other source encoder during operation.



Where only one common encoder is used, the select input of the first unit remains unconnected. The select inputs of all follower units are advantageously connected to the +pole of the power supply located next to the select input

4. Technical Specifications

Power supply:	Input voltage: 10 ... 30 VDC Protection circuit: reverse polarity protection Ripple: ≤ 10 % at 24 VDC Consumption: approx. 100 mA, with an unloaded encoder supply Connections: screw terminal, 1.5 mm ² / AWG 16
Encoder supply:	Description: switchable auxiliary voltage for 5 V encoders Output voltage: 5.5 VDC Output current: max. 200 mA, galvanically connected with the power supply Protection: <u>without</u> protection Connections: screw terminal, 1.5 mm ² , 8-pin Further possibilities: a) encoder supply by using a separate voltage source or b) use the 10 ... 30 V power source that already supplies the unit
Incremental input:	Signal levels (selectable): RS422 / TTL (differential voltage > 0.5 V), HTL (asymmetrical): LOW 0 ... 10 V, HIGH 15 ... 30 V LOW or HTL (symmetrical): 10 ... 30 V Channels: asymmetrical A, B, Z or symmetrical A, /A, B, /B, Z, /Z Frequency: max. 500 kHz at RS422 / TTL resp. max. 200 kHz at HTL Connections: coded screw terminal, 1.5 mm ² / AWG 16
Select input:	Signal levels: HIGH >15 V, LOW < 10 V Connections: screw terminal, 1.5 mm ² / AWG 16
Cascading in / out:	Signal levels: 5 V (CMOS, Low < 0.8 V, High >3.5 V) Channels: A, B, Z Signal delay time: 100 ns per further cascade Connections: optional flat-ribbon cable FK470 / 9-pin female D-SUB connector
Incremental outputs:	Number of outputs: 4 (GV471) resp. 8 (GV470) Output logic: push-pull Signal levels: 5 ... 30 V Signal delay time: 600 ns Output current: max. 30 mA Protection: shot circuit proof Connections: screw terminal, 1.5 mm ² / AWG 16
Potential separation:	GV470 / GV471 : potential separation between the input and the outputs
Indicators:	Number of indicators: 4 LEDs Function: 1 x green for "ready to operate" state and each 1 x yellow, red and orange for logical conditions of inputs A, B, Z
Housing:	Material: plastic Mounting: mounting rail (DIN, 35 mm C-Profile) Dimensions: 72 x 144 x 60.5 mm / 2.83 x 4.89 x 2.38 inches (w x h x d) without connectors and mounting kit 72 x 144 x 90.5 mm / 2.83 x 4.89 x 3.56 inches (w x h x d) inclusive connectors and mounting kit Protection: IP20 Weight: approx. 400 g
Ambient temperature:	Operation: 0 °C ... +50°C / +32 °F ... +122 °F (not condensing) Storage: -25 °C ... +75° C / -13°F ... +167 °F (not condensing)
Failure rate:	MTBF in years: GV470: 29.4 a (long-term usage at 60 °C / 140 °F) GV471: 40.0 a (long-term usage at 60 °C / 140 °F)
Conformity & standards:	EMC 2004/108/EC: EN 61000-6-2, EN 61000-6-3, EN 61000-6-4 Guideline 2011/65/EU: RoHS-conform

5. Dimensions

