

LEVEL INDICATOR PFG05

Product Line: **ROTARY**

Of durable and reliable manufacturing, particularly suitable for heavy operating conditions and extended working periods.
Version with 2 "1/2 Gas male thread for mounting with sleeve or flange.

ADVANTAGES

- An **EASY TO INSTALL** instrument that does not require any calibration, maintenance or specific tool for its installation.
- Thanks to the wide choice of paddles, all of which are interchangeable, it is **ADAPTABLE** to the different densities of the measured materials.
- Extremely **VERSATILE**, it can be installed on tanks, hoppers, on walls or roofs of silos, in a vertical, horizontal or oblique position.
- **CUSTOMIZABLE** with paddles, extensions, voltages and different electrical connection options.
- **DURABLE** and **RELIABLE** with ALUMINIUM casing, stainless steel shaft on ball bearings and electrical connection via anti-vibration faston terminals. Works with ambient temperatures from -20° to +70°C.
- On request:
 - Condensation Filter:** helps preventing the formation of condensation in the level indicator casing.
 - 8 Pulses** for rotation control: remotely notifying that the level indicator is working correctly.
 - Voltage Control:** to check the correct power supply of the level indicator.
 - Double Contact:** the level indicator will have one additional dry contact.
 - 4 RPM:** to decrease the intervention time of the level indicator.
 - Low Temperatures:** allows the indicator to operate up to -27°C.



Solids



ATEX CERTIFICATE FOR DUST ZONE 20/21

LEVEL INDICATOR PFG05

Product Line: **ROTARY**



Solids

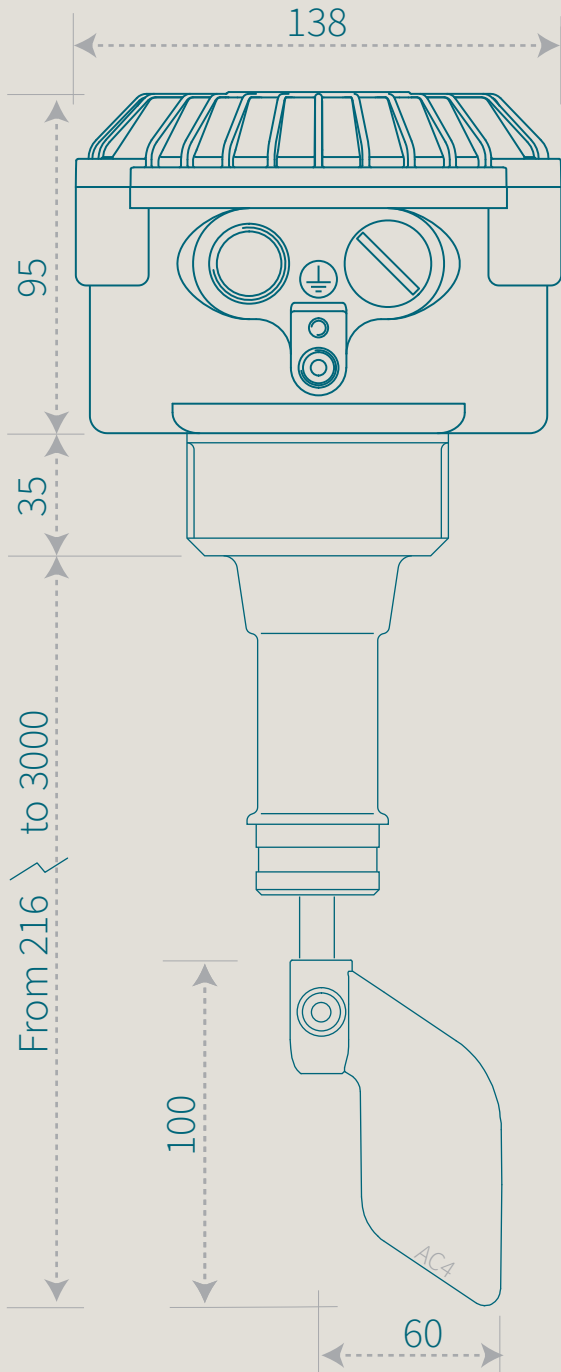

Customizations

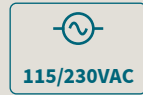

110/220 V AC

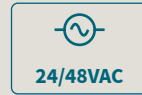

24/48 V AC



24 V DC



Voltage control



Double contact



8 pulse



4 RPM



Low temperatures

Lamp



220VAC



110VAC



48VAC



24VAC



24VDC

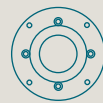

Aluminium flange

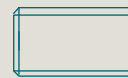

Iron sleeve
2"1/2Gas

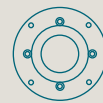

Stainless steel
flange

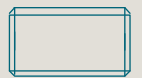

Stainless steel
2"1/2Gas



Iron extension with protection
from 216 to 3000 mm



Stainless steel extension with protection
from 216 to 3000 mm

Stainless steel



AC1



AC3



AC4



AC5



AC5L



AC6



AC7



AC8



AC9



AC10



AC11



AC12



AC14



AC15



AC16

Nylon6



AC1



AC2



AC4



AC9



AC13

