



High power cycling capability
Low on-state and switching losses
Designed for traction and industrial applications

Phase Control Thyristor Type T233-500-18

Mean on-state current				I_{TAV}		500 A		
Repetitive peak off-state voltage				V_{DRM}		1000 ÷ 1800 V		
Repetitive peak reverse voltage				V_{RRM}				
Turn-off time				t_q		125, 160, 200, 250, 320, 400, 500 μ s		
V_{DRM}, V_{RRM}, V	1000	1100	1200	1300	1400	1500	1600	1800
Voltage code	10	11	12	13	14	15	16	18
$T_j, ^\circ C$	-60 ÷ 125							

MAXIMUM ALLOWABLE RATINGS

Symbols and parameters		Units	Values	Test conditions
ON-STATE				
I_{TAV}	Mean on-state current	A	500 592	$T_c=93^\circ C$, Double side cooled $T_c=85^\circ C$, Double side cooled 180° half-sine wave; 50 Hz
I_{TRMS}	RMS on-state current	A	785	$T_c=93^\circ C$, Double side cooled 180° half-sine wave; 50 Hz
I_{TSM}	Surge on-state current	kA	7.0 8.0	$T_j=T_{j\ max}$ $T_j=25^\circ C$ 180° half-sine wave; $t_p=10\ ms$; single pulse; $V_D=V_R=0\ V$; Gate pulse: $I_G=2\ A$; $t_{GP}=50\ \mu s$; $di_G/dt \geq 1\ A/\mu s$
			7.5 8.5	$T_j=T_{j\ max}$ $T_j=25^\circ C$ 180° half-sine wave; $t_p=8.3\ ms$; single pulse; $V_D=V_R=0\ V$; Gate pulse: $I_G=2\ A$; $t_{GP}=50\ \mu s$; $di_G/dt \geq 1\ A/\mu s$
I^2t	Safety factor	$A^2s \cdot 10^3$	240 320	$T_j=T_{j\ max}$ $T_j=25^\circ C$ 180° half-sine wave; $t_p=10\ ms$; single pulse; $V_D=V_R=0\ V$; Gate pulse: $I_G=2\ A$; $t_{GP}=50\ \mu s$; $di_G/dt \geq 1\ A/\mu s$
			230 290	$T_j=T_{j\ max}$ $T_j=25^\circ C$ 180° half-sine wave; $t_p=8.3\ ms$; single pulse; $V_D=V_R=0\ V$; Gate pulse: $I_G=2\ A$; $t_{GP}=50\ \mu s$; $di_G/dt \geq 1\ A/\mu s$
BLOCKING				
V_{DRM}, V_{RRM}	Repetitive peak off-state and Repetitive peak reverse voltages	V	1000 ÷ 1800	$T_{j\ min} < T_j < T_{j\ max}$; 180° half-sine wave; 50 Hz; Gate open
V_{DSM}, V_{RSM}	Non-repetitive peak off-state and Non-repetitive peak reverse voltages	V	1100 ÷ 1900	$T_{j\ min} < T_j < T_{j\ max}$; 180° half-sine wave; single pulse; Gate open
V_D, V_R	Direct off-state and Direct reverse voltages	V	$0.6 \cdot V_{DRM}$ $0.6 \cdot V_{RRM}$	$T_j=T_{j\ max}$; Gate open

TRIGGERING				
I_{FGM}	Peak forward gate current	A	6	$T_j = T_{j\ max}$
V_{RGM}	Peak reverse gate voltage	V	5	
P_G	Gate power dissipation	W	3	$T_j = T_{j\ max}$ for DC gate current
SWITCHING				
$(di_T/dt)_{crit}$	Critical rate of rise of on-state current non-repetitive (f=1 Hz)	A/ μ s	1000	$T_j = T_{j\ max}$; $V_D = 0.67 \cdot V_{DRM}$; $I_{TM} = 1700$ A; Gate pulse: $I_G = 2$ A; $t_{GP} = 50$ μ s; $di_G/dt \geq 2$ A/ μ s
THERMAL				
T_{stg}	Storage temperature	$^{\circ}$ C	-60÷50	
T_j	Operating junction temperature	$^{\circ}$ C	-60÷125	
MECHANICAL				
F	Mounting force	kN	9.0÷11.0	
a	Acceleration	m/s ²	50	Device clamped

CHARACTERISTICS

Symbols and parameters		Units	Values	Conditions	
ON-STATE					
V_{TM}	Peak on-state voltage, max	V	1.70	$T_j = 25$ $^{\circ}$ C; $I_{TM} = 1570$ A	
$V_{T(TO)}$	On-state threshold voltage, max	V	0.919	$T_j = T_{j\ max}$;	
r_T	On-state slope resistance, max	m Ω	0.529	$0.5 \pi I_{TAV} < I_T < 1.5 \pi I_{TAV}$	
I_L	Latching current, max	mA	700	$T_j = 25$ $^{\circ}$ C; $V_D = 12$ V; Gate pulse: $I_G = 2$ A; $t_{GP} = 50$ μ s; $di_G/dt \geq 1$ A/ μ s	
I_H	Holding current, max	mA	300	$T_j = 25$ $^{\circ}$ C; $V_D = 12$ V; Gate open	
BLOCKING					
I_{DRM}, I_{RRM}	Repetitive peak off-state and Repetitive peak reverse currents, max	mA	70	$T_j = T_{j\ max}$; $V_D = V_{DRM}$; $V_R = V_{RRM}$	
$(dv_D/dt)_{crit}$	Critical rate of rise of off-state voltage ¹⁾ , min	V/ μ s	200, 320, 500, 1000, 1600, 2000, 2500	$T_j = T_{j\ max}$; $V_D = 0.67 \cdot V_{DRM}$; Gate open	
TRIGGERING					
V_{GT}	Gate trigger direct voltage, max	V	3.00 2.50 1.50	$T_j = T_{j\ min}$ $T_j = 25$ $^{\circ}$ C $T_j = T_{j\ max}$	$V_D = 12$ V; $I_D = 3$ A; Direct gate current
I_{GT}	Gate trigger direct current, max	mA	400 250 150	$T_j = T_{j\ min}$ $T_j = 25$ $^{\circ}$ C $T_j = T_{j\ max}$	
V_{GD}	Gate non-trigger direct voltage, min	V	0.60	$T_j = T_{j\ max}$;	
I_{GD}	Gate non-trigger direct current, min	mA	35.00	$V_D = 0.67 \cdot V_{DRM}$; Direct gate current	
SWITCHING					
t_{gd}	Delay time, max	μ s	1.25	$T_j = 25$ $^{\circ}$ C; $V_D = 1000$ V; $I_{TM} = I_{TAV}$; $di/dt = 200$ A/ μ s;	
t_{gt}	Turn-on time, max	μ s	4.00	Gate pulse: $I_G = 2$ A; $V_G = 20$ V; $t_{GP} = 50$ μ s; $di_G/dt = 2$ A/ μ s	
t_q	Turn-off time ²⁾ , max	μ s	125, 160, 200, 250, 320, 400, 500	$dv_D/dt = 50$ V/ μ s; $T_j = T_{j\ max}$; $I_{TM} = I_{TAV}$; $di_R/dt = -10$ A/ μ s; $V_R = 100$ V; $V_D = 0.67 \cdot V_{DRM}$	
Q_{rr}	Total recovered charge, max	μ C	750	$T_j = T_{j\ max}$; $I_{TM} = 500$ A;	
t_{rr}	Reverse recovery time, max	μ s	15	$di_R/dt = -10$ A/ μ s;	
I_{rrM}	Peak reverse recovery current, max	A	100	$V_R = 100$ V	

THERMAL					
R_{thjc}	Thermal resistance, junction to case, max	°C/W	0.040	Direct current	Double side cooled
R_{thjc-A}			0.088		Anode side cooled
R_{thjc-K}			0.072		Cathode side cooled
R_{thck}	Thermal resistance, case to heatsink, max	°C/W	0.008	Direct current	
MECHANICAL					
w	Weight, max	g	110		
D_s	Surface creepage distance	mm (inch)	10.30 (0.405)		
D_a	Air strike distance	mm (inch)	6.30 (0.248)		

PART NUMBERING GUIDE								NOTES																							
T	233	500	18	A2	X2	N		1) Critical rate of rise of off-state voltage																							
1	2	3	4	5	6	7		<table border="1"> <thead> <tr> <th>Symbol of Group</th> <th>P2</th> <th>K2</th> <th>E2</th> <th>A2</th> <th>T1</th> <th>P1</th> <th>M1</th> </tr> </thead> <tbody> <tr> <td>$(dv_D/dt)_{crit}, V/\mu s$</td> <td>200</td> <td>320</td> <td>500</td> <td>1000</td> <td>1600</td> <td>2000</td> <td>2500</td> </tr> </tbody> </table>								Symbol of Group	P2	K2	E2	A2	T1	P1	M1	$(dv_D/dt)_{crit}, V/\mu s$	200	320	500	1000	1600	2000	2500
Symbol of Group	P2	K2	E2	A2	T1	P1	M1																								
$(dv_D/dt)_{crit}, V/\mu s$	200	320	500	1000	1600	2000	2500																								
1. Phase Control Thyristor 2. Design version 3. Mean on-state current, A 4. Voltage code 5. Critical rate of rise of off-state voltage, V/ μs 6. Turn-off time ($dv_D/dt=50 V/\mu s$) 7. Ambient conditions: N – normal; T – tropical								2) Turn-off time ($dv_D/dt=50 V/\mu s$) <table border="1"> <thead> <tr> <th>Symbol of Group</th> <th>X2</th> <th>T2</th> <th>P2</th> <th>M2</th> <th>K2</th> <th>H2</th> <th>E2</th> </tr> </thead> <tbody> <tr> <td>$t_{gr}, \mu s$</td> <td>125</td> <td>160</td> <td>200</td> <td>250</td> <td>320</td> <td>400</td> <td>500</td> </tr> </tbody> </table>								Symbol of Group	X2	T2	P2	M2	K2	H2	E2	$t_{gr}, \mu s$	125	160	200	250	320	400	500
Symbol of Group	X2	T2	P2	M2	K2	H2	E2																								
$t_{gr}, \mu s$	125	160	200	250	320	400	500																								

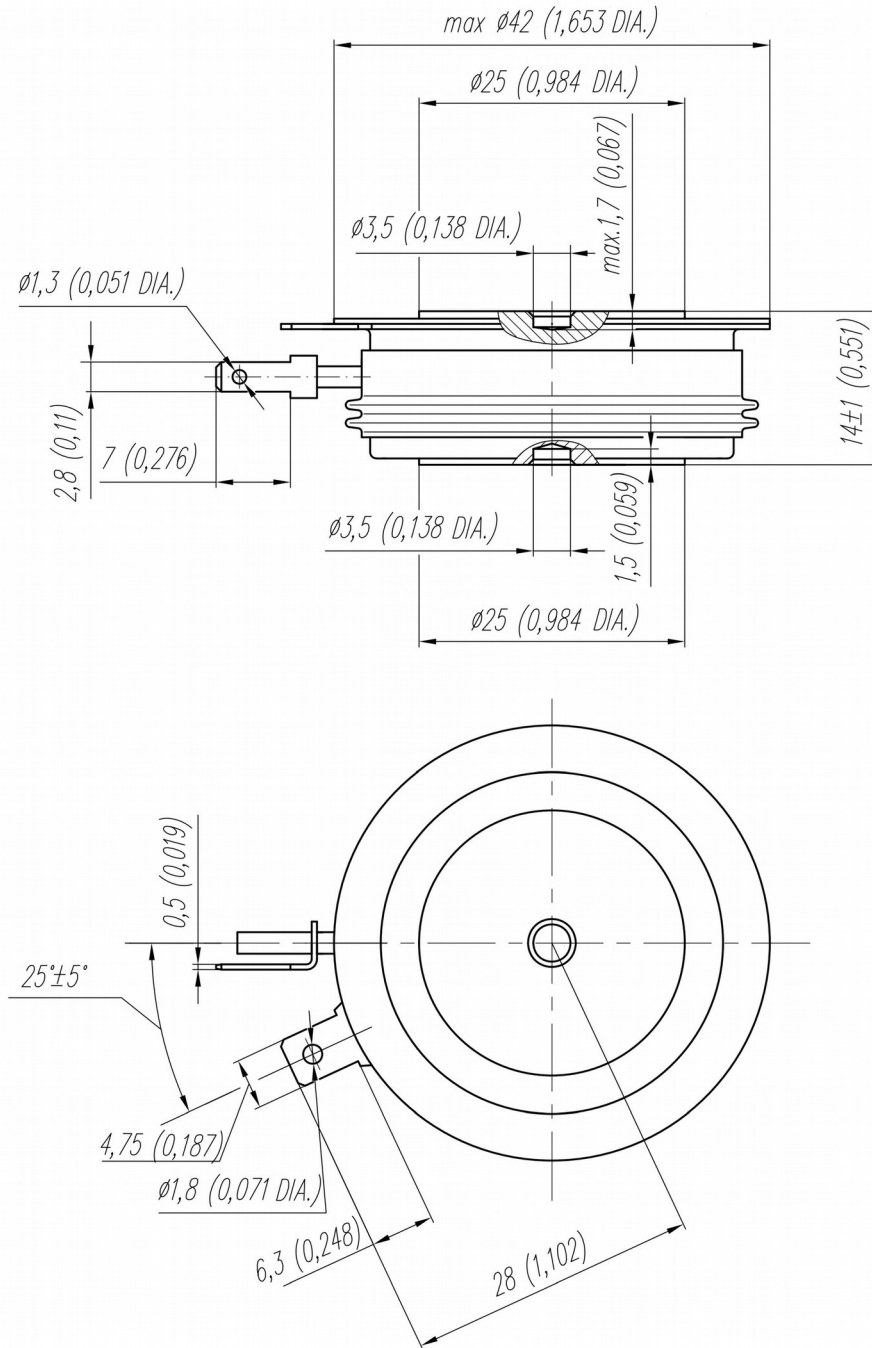

All dimensions in millimeters (inches)

The information contained herein is confidential and protected by Copyright. In the interest of product improvement, Proton-Electrotex reserves the right to change data sheet without notice.

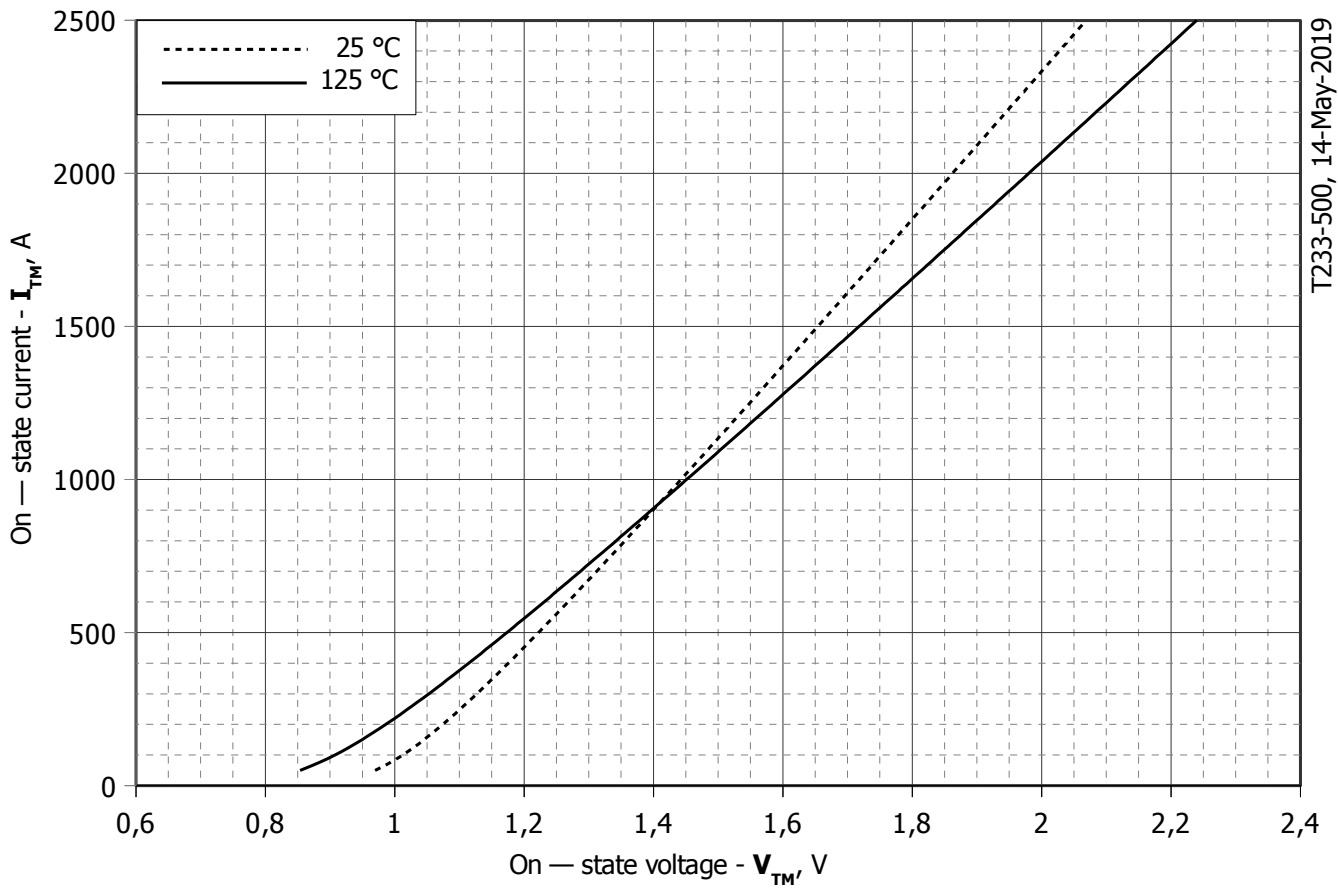

T233-500, 14-May-2019

Fig 1 – On-state characteristics of Limit device

Analytical function for On-state characteristic:

$$V_T = A + B \cdot i_T + C \cdot \ln(i_T + 1) + D \cdot \sqrt{i_T}$$

	Coefficients for max curves	
	$T_j = 25^\circ\text{C}$	$T_j = T_{j\text{max}}$
A	0.81206000	0.65641000
B	0.00040593	0.00050753
C	0.03645500	0.04506900
D	-0.00086613	-0.00075974

On-state characteristic model (see Fig. 1)

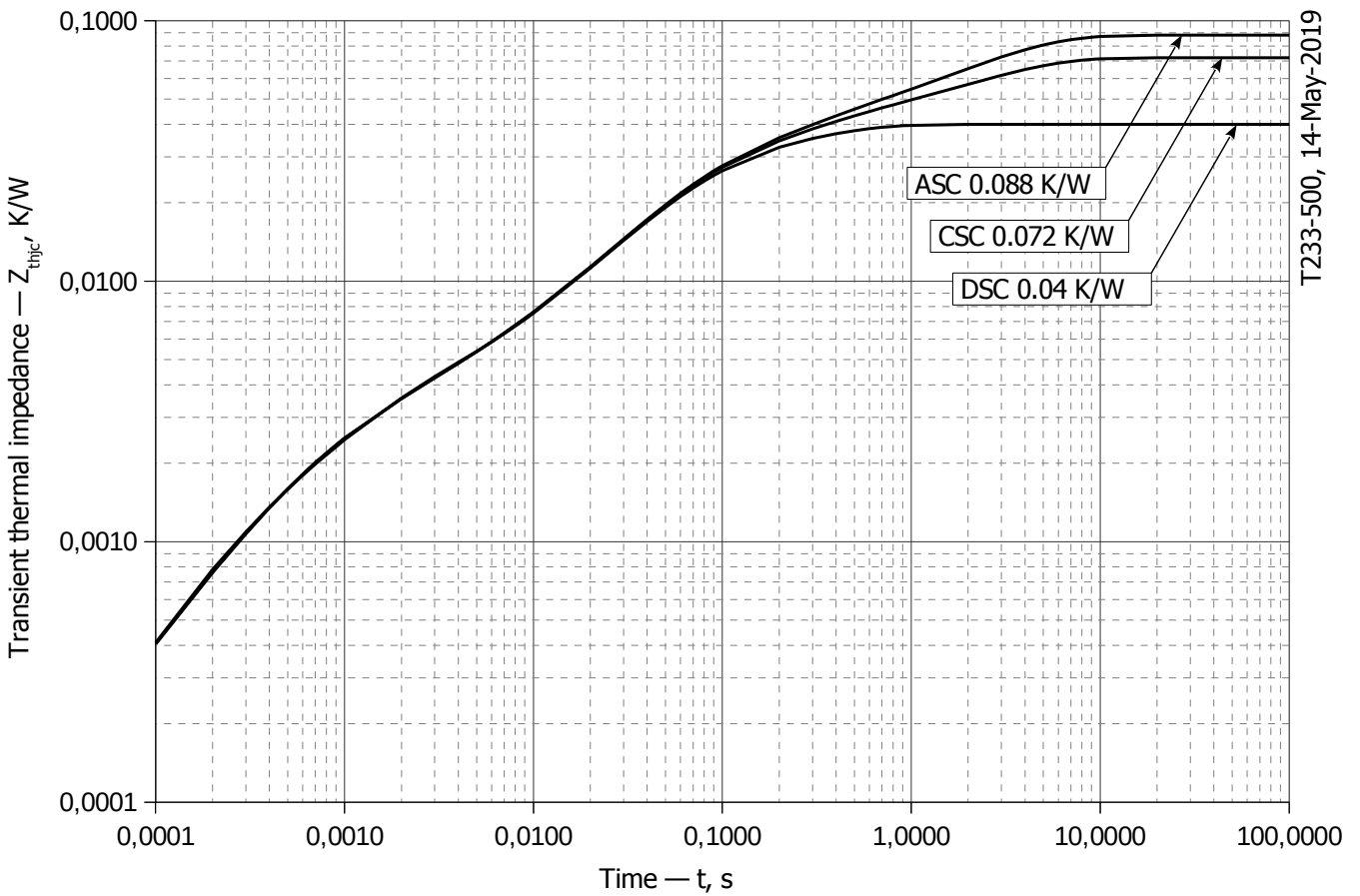

T233-500, 14-May-2019

Fig 2 – Transient thermal impedance Z_{thjc} vs. time t

Analytical function for Transient thermal impedance junction to case Z_{thjc} for DC:

$$Z_{thjc} = \sum_{i=1}^n R_i \left(1 - e^{-\frac{t}{\tau_i}} \right)$$

Where $i = 1$ to n , n is the number of terms in the series.

t = Duration of heating pulse in seconds.

Z_{thjc} = Thermal resistance at time t .

R_i = Amplitude of p_{th} term.

τ_i = Time constant of r_{th} term.

DC Double side cooled

i	1	2	3	4	5	6
R_i , K/W	0.01423	0.01906	0.003576	0.002535	-4.666e-005	0.0006479
τ_i , s	0.265	0.05901	0.03499	0.001252	0.000001	0.0002488

DC Anode side cooled

i	1	2	3	4	5	6
R_i , K/W	0.04804	0.001789	0.01342	0.02147	0.001374	0.001945
τ_i , s	2.651	0.4195	0.2622	0.05451	0.002585	0.0005847

DC Cathode side cooled

i	1	2	3	4	5	6
R_i , K/W	0.03216	0.01306	0.002934	0.02064	0.001493	0.001786
τ_i , s	2.647	0.2831	0.1455	0.05284	0.002255	0.0005519

Transient thermal impedance junction to case Z_{thjc} model (see Fig. 2)

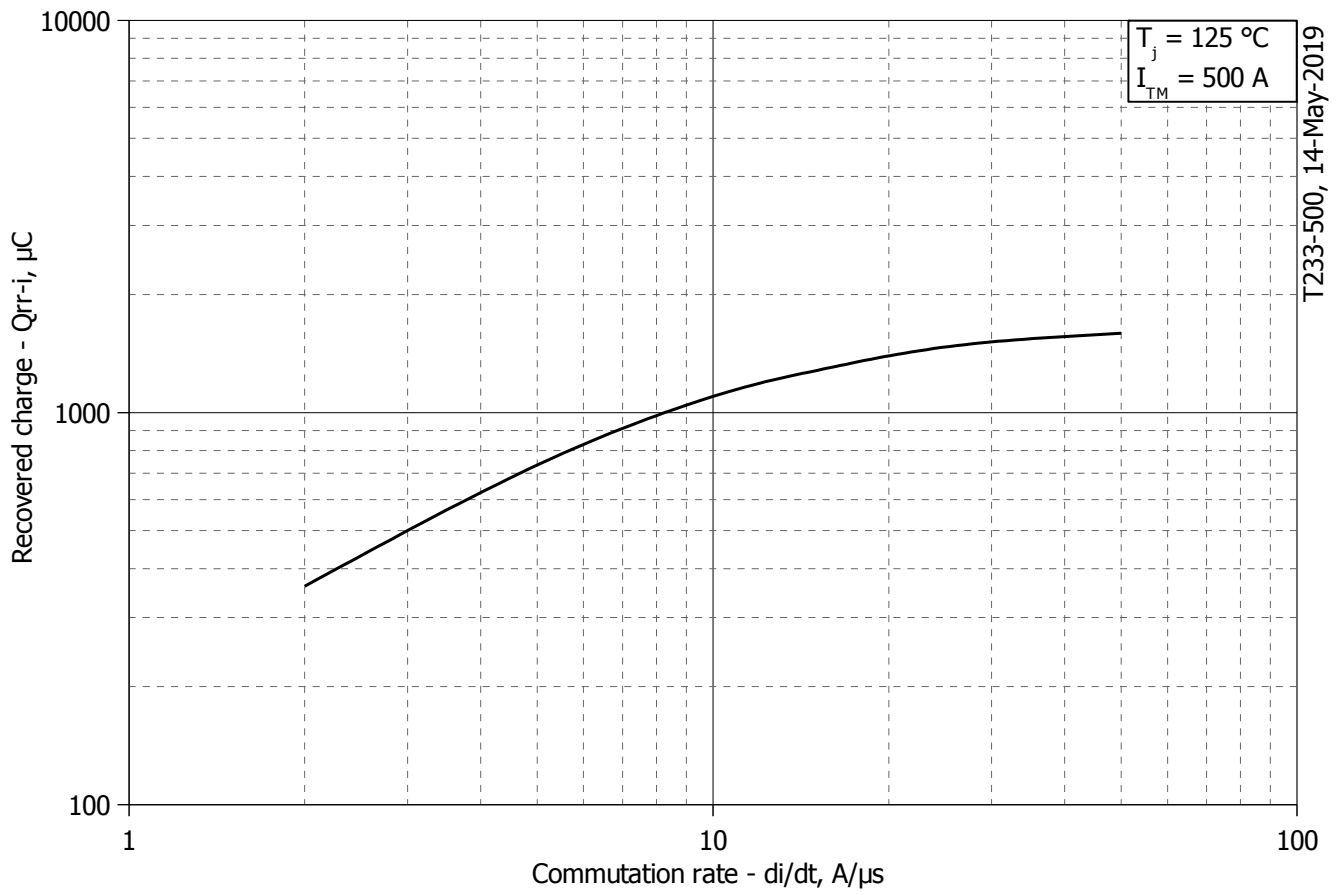

Fig 3 – Maximum recovered charge Q_{rr-i} (integral) vs. commutation rate di_R/dt

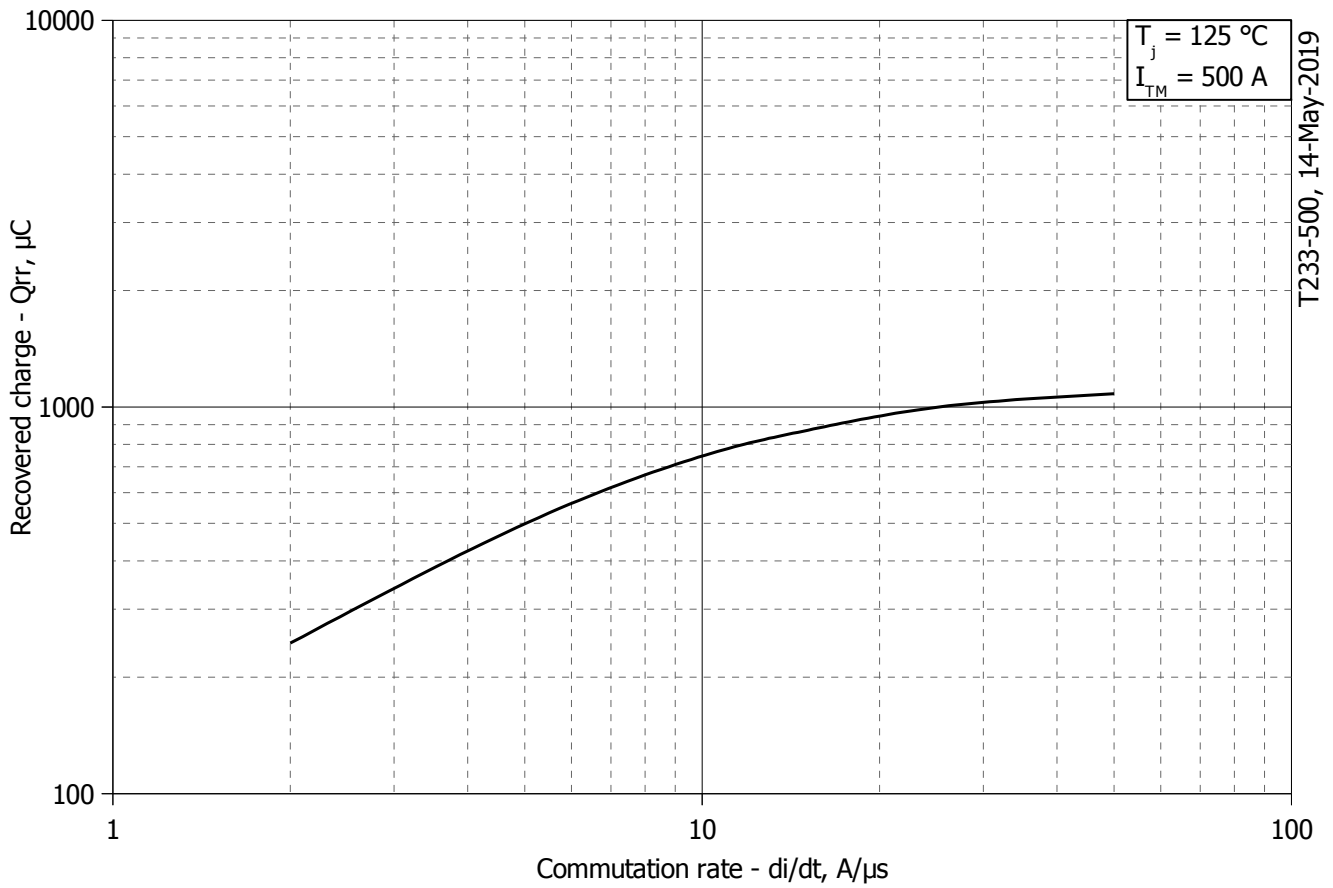

Fig 4 – Maximum recovered charge Q_{rr} vs. commutation rate di_R/dt (25% chord)

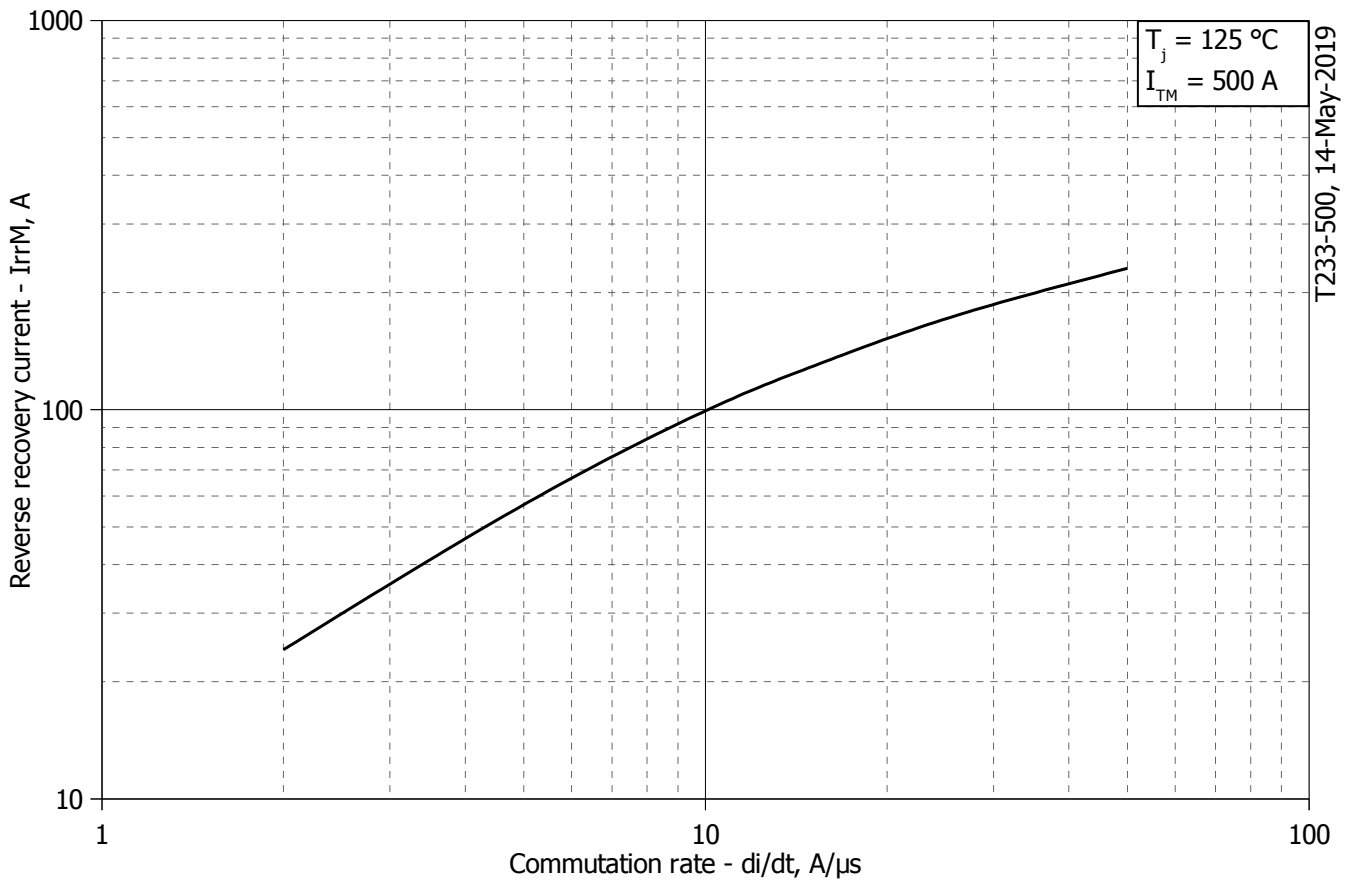

Fig 5 – Maximum reverse recovery current I_{rrM} vs. commutation rate di_R/dt

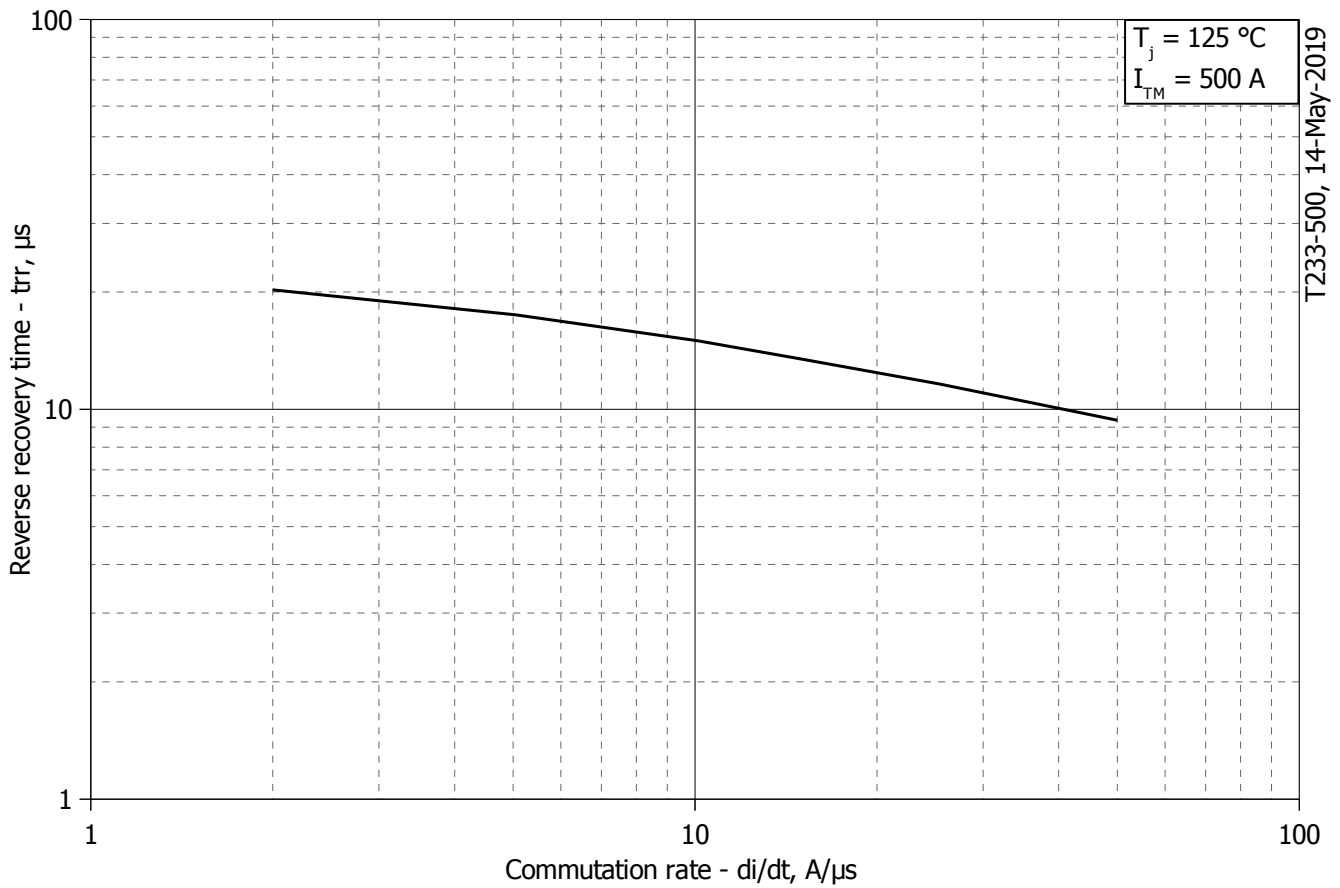
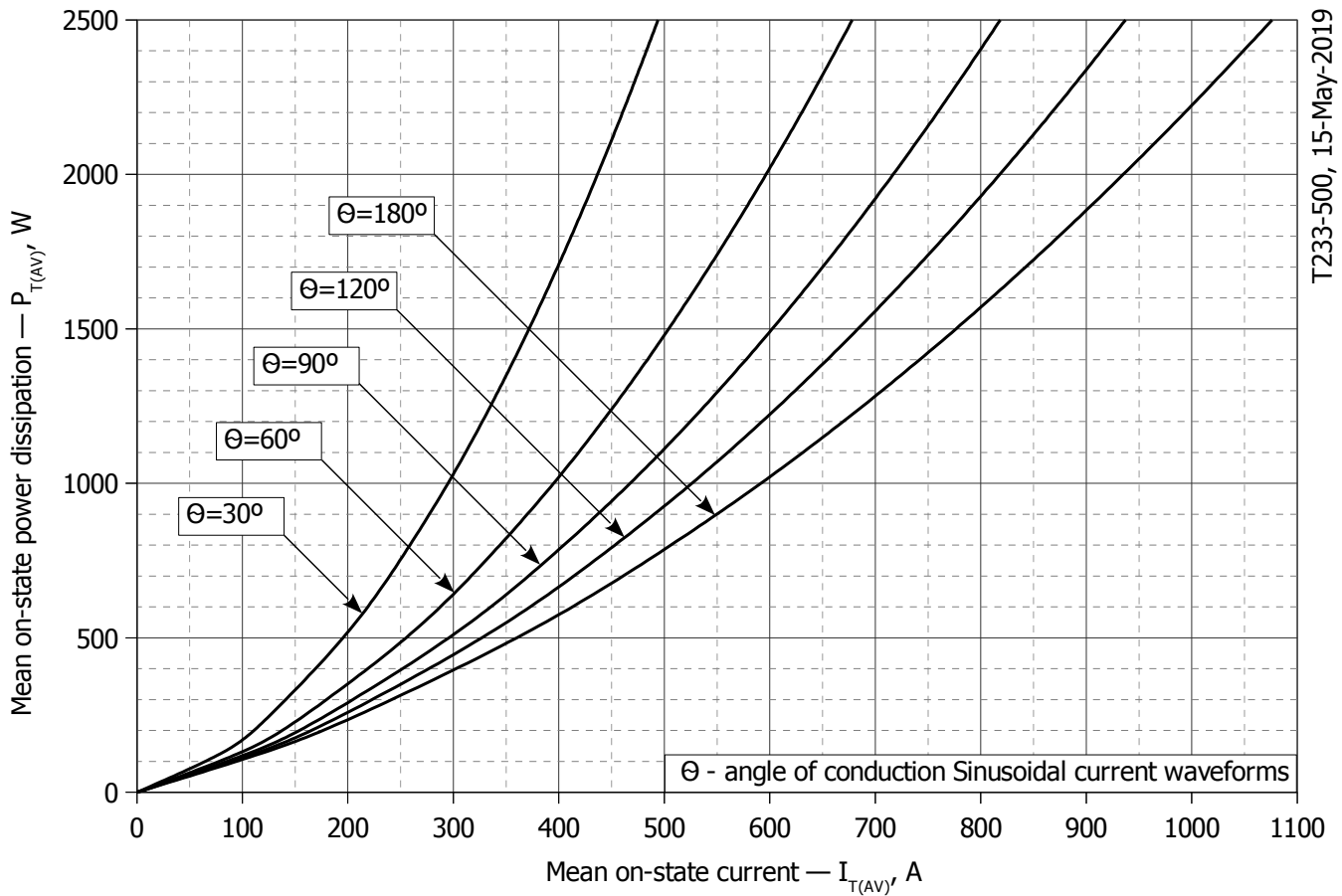
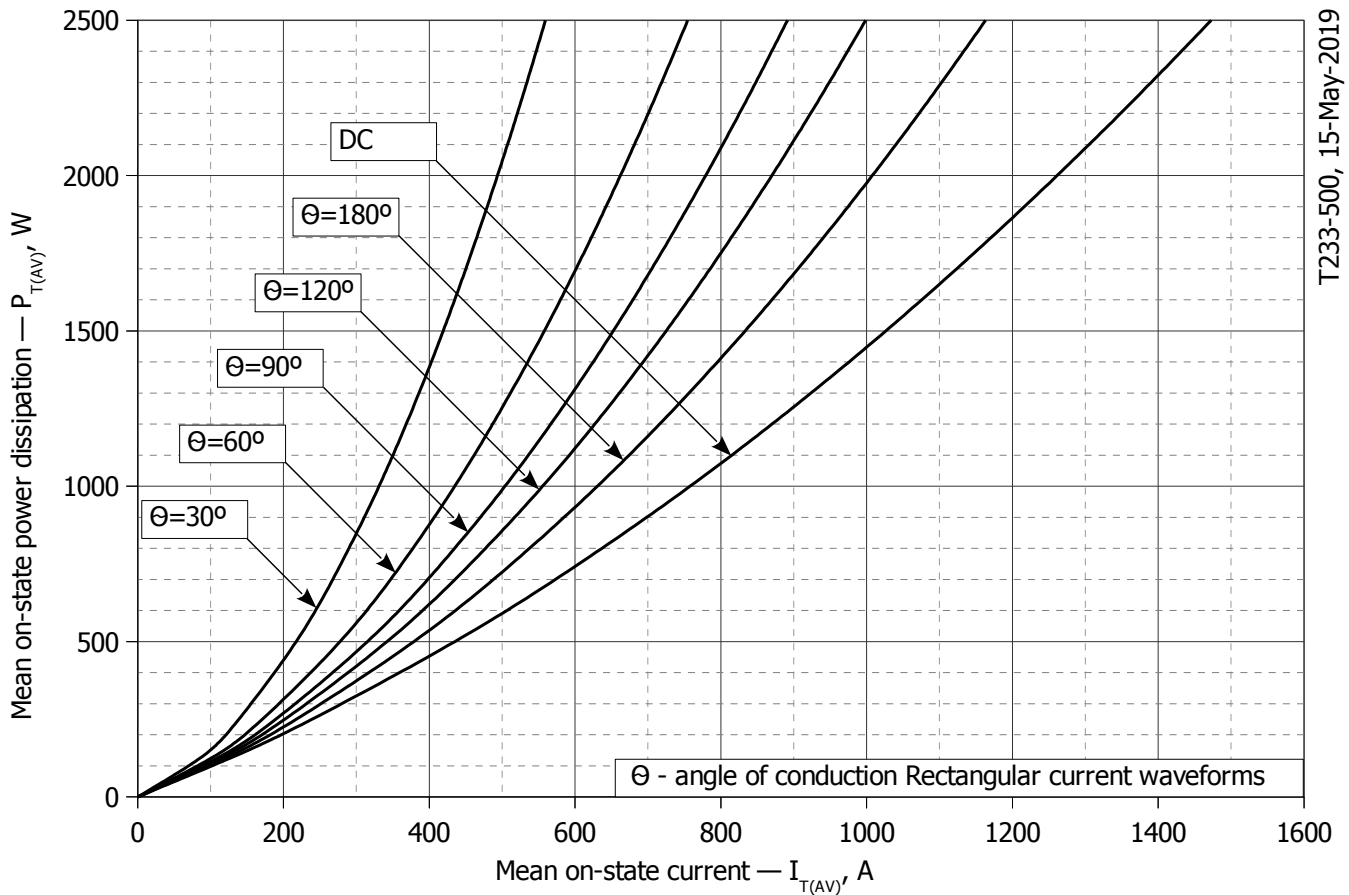

Fig 6 – Maximum recovery time t_r vs. commutation rate di_R/dt (25% chord)



T233-500, 15-May-2019

Fig. 7 - Mean on-state power dissipation P_{TAV} vs. mean on-state current I_{TAV} for sinusoidal current waveforms at different conduction angles ($f=50\text{Hz}$, DSC)



T233-500, 15-May-2019

Fig. 8 – Mean on-state power dissipation P_{TAV} vs. mean on-state current I_{TAV} for rectangular current waveforms at different conduction angles and for DC ($f=50\text{Hz}$, DSC)

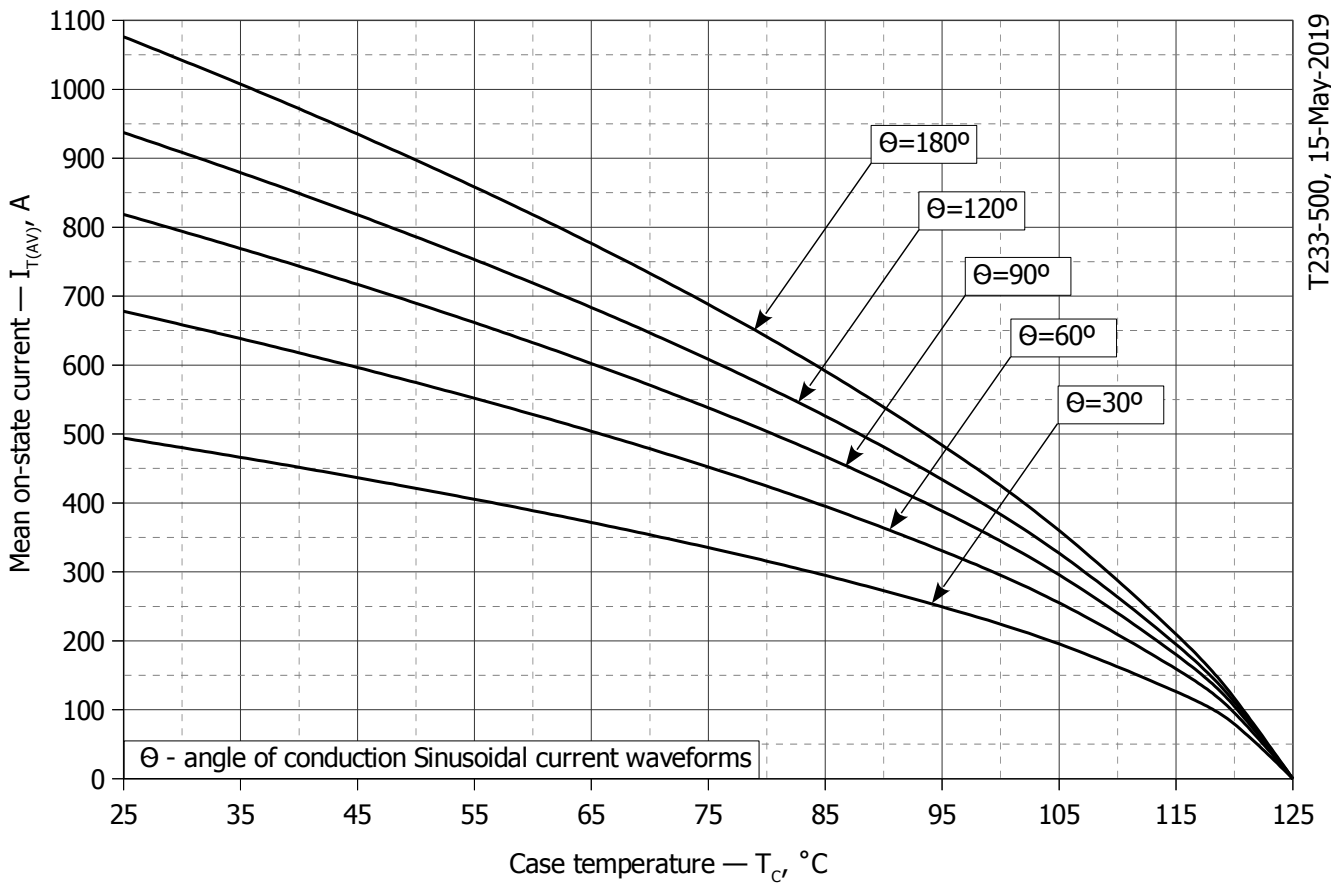

Fig. 9 – Mean on-state current I_{TAV} vs. case temperature T_C for sinusoidal current waveforms at different conduction angles ($f=50\text{Hz}$, DSC)

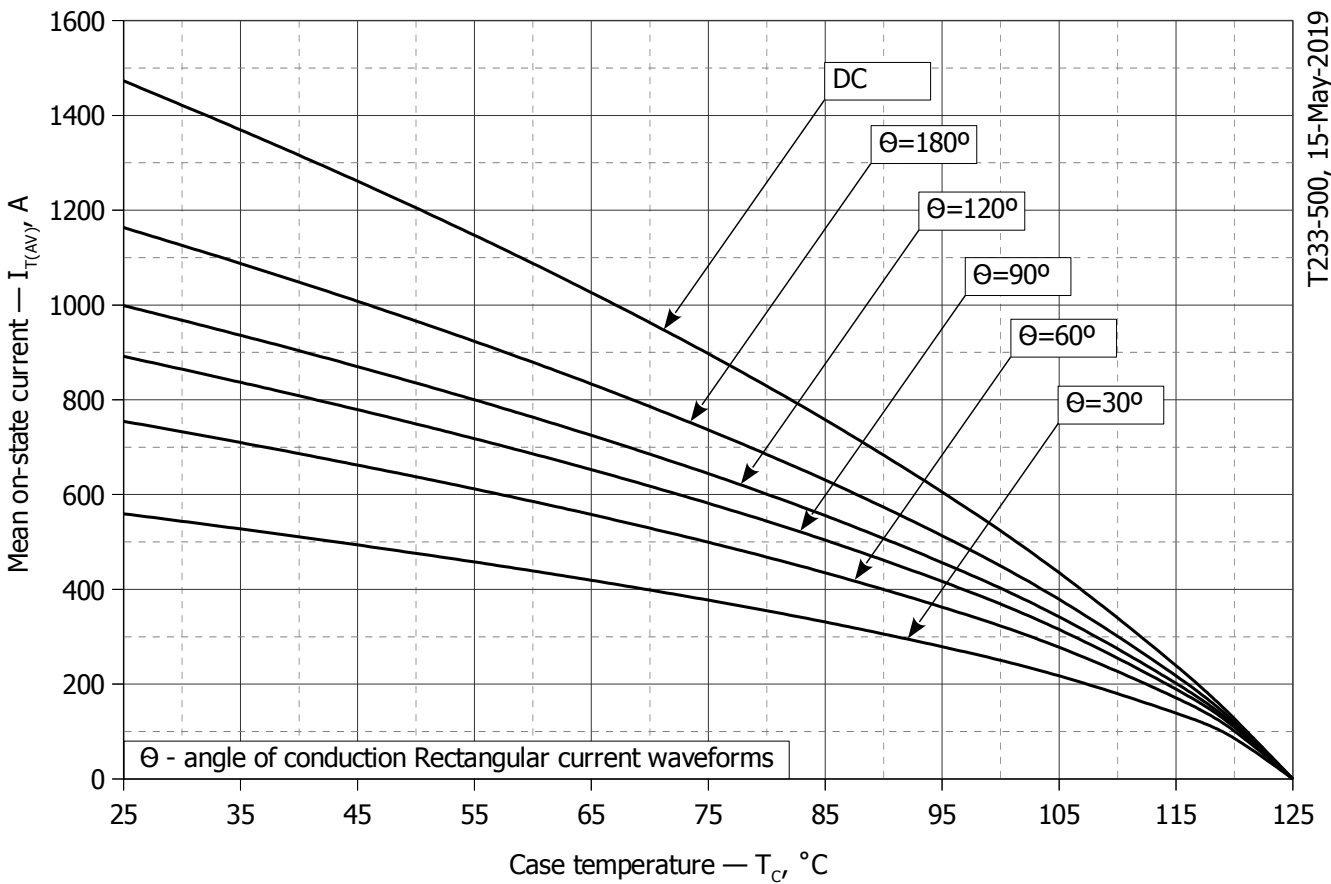

Fig. 10 - Mean on-state current I_{TAV} vs. case temperature T_C for rectangular current waveforms at different conduction angles and for DC ($f=50\text{Hz}$, DSC)

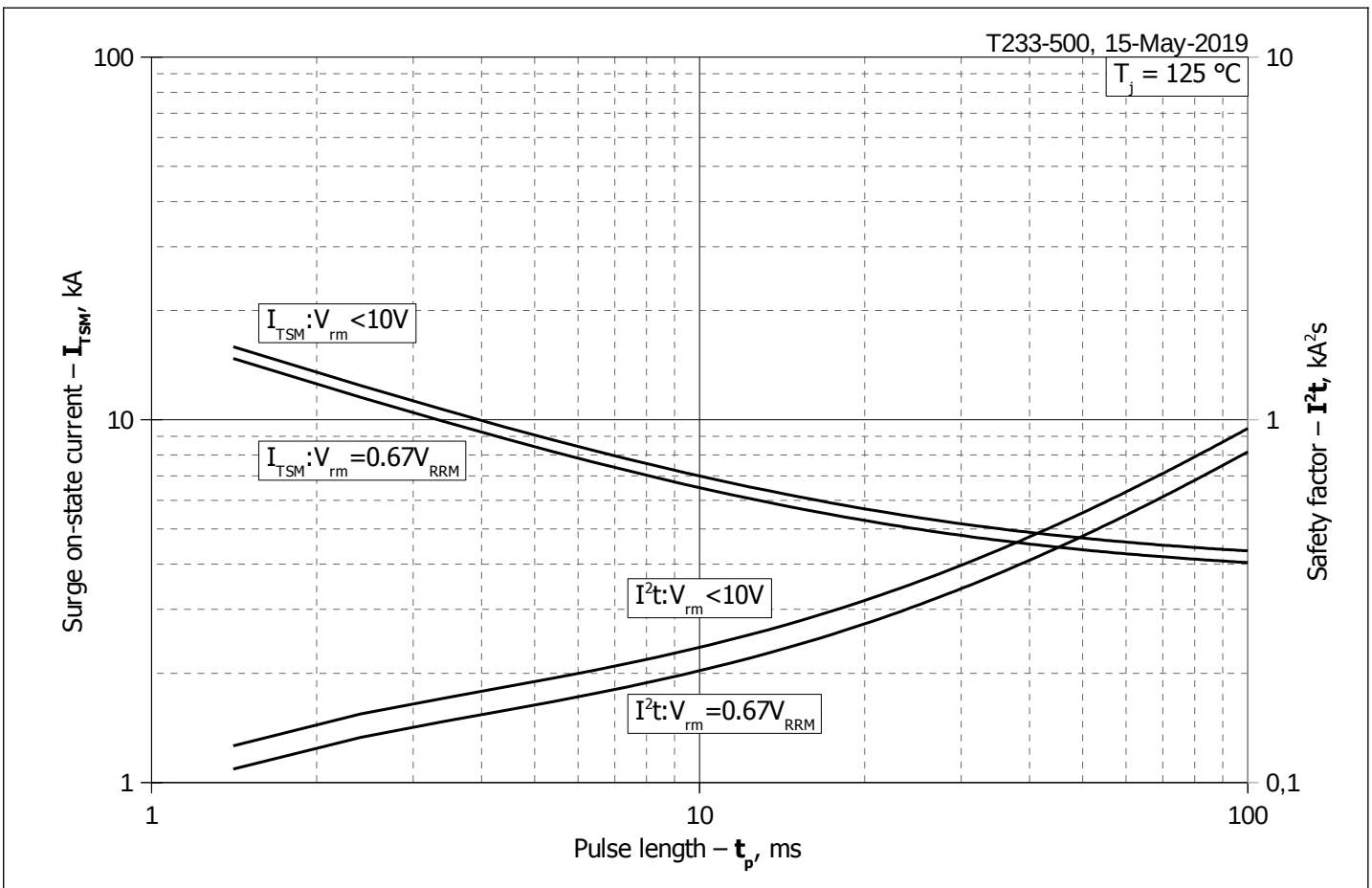

Fig. 11 – Maximum surge on-state current I_{TSM} and safety factor I^2t vs. pulse length t_p

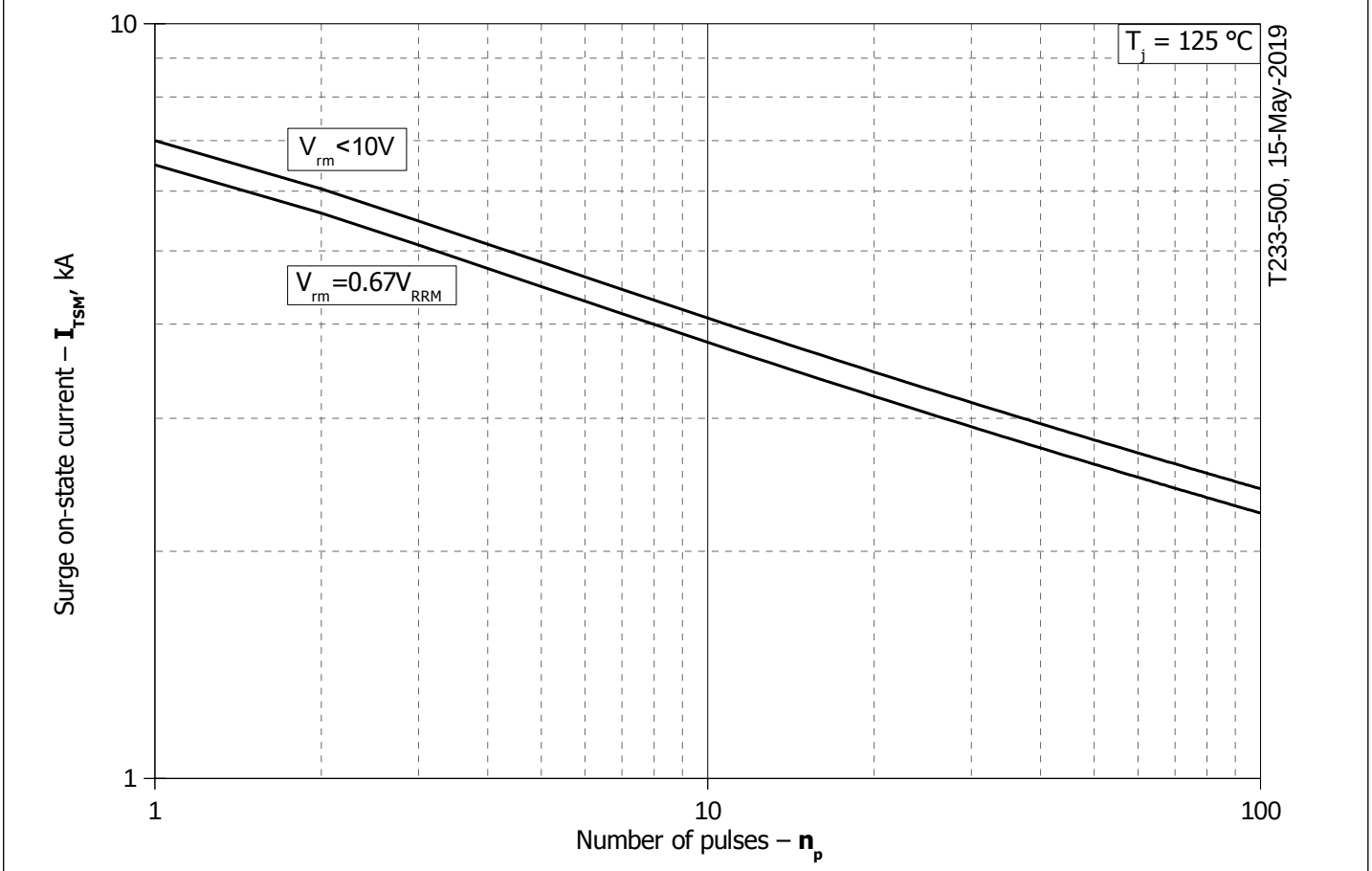

Fig. 12 - Maximum surge on-state current I_{TSM} vs. number of pulses n_p