**NF 320 battery connector**
**Request an offer**

Are you interested in this product? Do you need additional information or individual pricing?

Contact us

 **227035225**
 **pzl\_i@dacpol.eu**

## Product information

### Battery connector NF 320

#### Characteristics:

- Voltage: 150V DC max
- Amperage: 320A
- Temperature range: -20°C / +90°C
- Housing: acidproof plastic
- Contacts: copper alloy, silver plated, (to crimp or to solder)
- Amperage of auxiliary contact: 20 A
- Section of auxiliary contact: 2,5 mm<sup>2</sup> i 4 mm<sup>2</sup>
- Watertightness: IP23
- Normes: NF EN 1175-1 and DIN VDE 0623-589

#### Complete connectors:

	Ref.	Description	Section	
			mm <sup>2</sup>	AWG
<b>Connector</b>	<b>169320</b>	Male 95 mm <sup>2</sup> + reducer 70 mm <sup>2</sup>	95/70	2/0
	<b>169321</b>	Male	50	1/0
	<b>169322</b>	Male	70	2/0
	<b>169323</b>	Male	95	3/0
<b>Connector</b>	<b>169325</b>	Female	50	1/0
	<b>169326</b>	Female	70	2/0
	<b>169327</b>	Female	95	3/0
	<b>169328</b>	Female 95 mm <sup>2</sup> + reducer 70 mm <sup>2</sup>	95/70	2/0
<b>Auxiliary contacts</b>	<b>169355</b>	Male - 32 A	4	12
	<b>169357</b>	Female - 32 A	4	12



<b>Air contacts</b>	<b>169354</b>	Male	-
	<b>169359</b>	Female	
<b>Handle</b>	<b>169339</b>	Black color	-
	<b>169339-R</b>	Red color	
	<b>169339-RH</b>	Red color - reinforced	
<b>Dust cap</b>	<b>169195</b>	Female	-
	<b>169200</b>	Male	

**Spare parts:**

	Ref.	Description	Section	
			mm2	AWG
<b>Contact</b>	<b>169340</b>	Male 95 mm <sup>2</sup> + reducer 70 mm <sup>2</sup>	95/70	2/0
	<b>169341</b>	Male	50	1/0
	<b>169342</b>	Male	70	2/0
	<b>169343</b>	Male	95	3/0
<b>Contact</b>	<b>169345</b>	Female	50	1/0
	<b>169346</b>	Female	70	2/0
	<b>169347</b>	Female	95	3/0
	<b>169350</b>	Female 95 mm <sup>2</sup> + reducer 70 mm <sup>2</sup>	95/70	2/0
<b>Housing</b>	<b>169350</b>	Male	-	
	<b>169351</b>	Female	-	
<b>Reducers</b>	<b>169194</b>	70 mm <sup>2</sup> / 50 mm <sup>2</sup>	-	
	<b>169195</b>	95 mm <sup>2</sup> / 70 mm <sup>2</sup>	-	
<b>Voltage coding key</b>	<b>169392</b>	Black color wet battery	-	
	<b>169393</b>	Grey color gel battery	-	

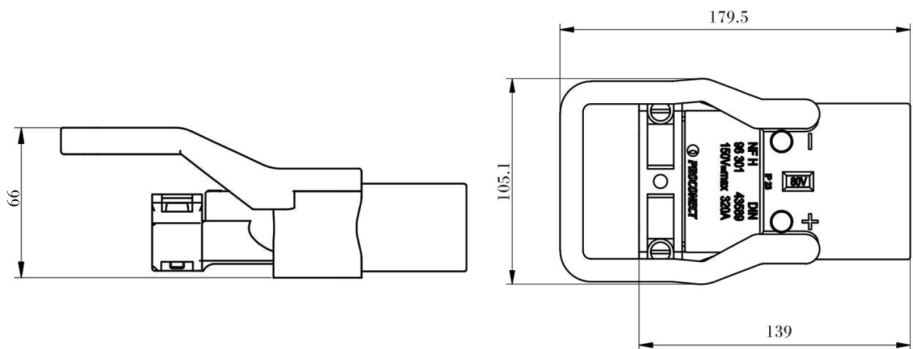
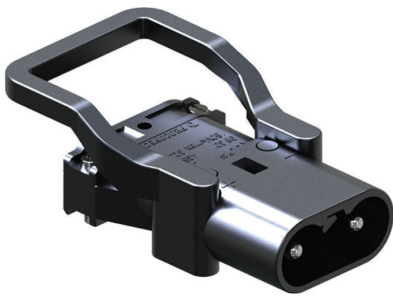
**NF 320 Male****NF 320 Female**

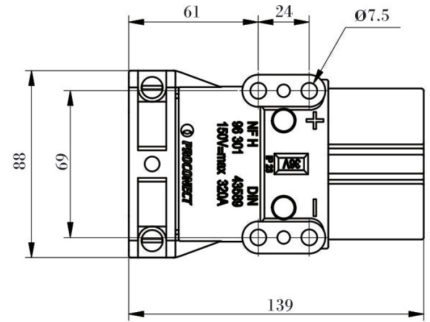
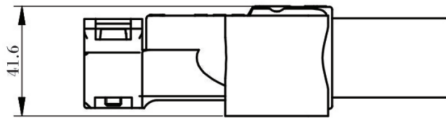

**NF 320 Connector**

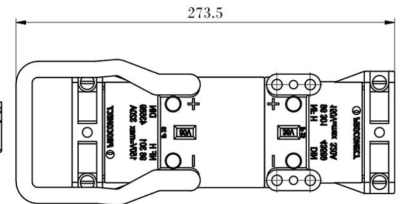
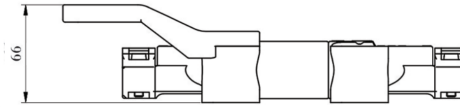
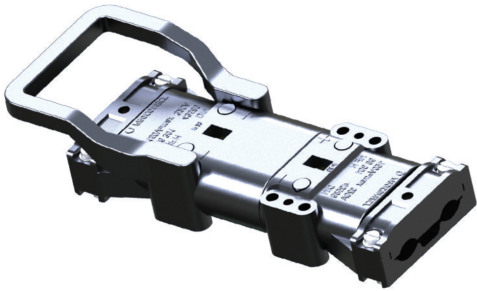

**NF 320 Male dust cap**



**169200**

**NF 320 Female dust cap**



**169195**

